

# Appraising the extractable tidal energy resource of the UK's western coastal waters

Nick Yates, Ian Walkington, Richard Burrows and Judith Wolf

*Phil. Trans. R. Soc. A* 2013 **371**, 20120181

---

## References

This article cites 7 articles, 2 of which can be accessed free  
<http://rsta.royalsocietypublishing.org/content/371/1985/20120181.full.html#ref-list-1>

## Subject collections

Articles on similar topics can be found in the following collections

[ocean engineering](#) (27 articles)

## Email alerting service

Receive free email alerts when new articles cite this article - sign up in the box at the top right-hand corner of the article or click [here](#)

## Research



**Cite this article:** Yates N, Walkington I, Burrows R, Wolf J. 2013 Appraising the extractable tidal energy resource of the UK's western coastal waters. *Phil Trans R Soc A* 371: 20120181.

<http://dx.doi.org/10.1098/rsta.2012.0181>

One contribution of 14 to a Theme Issue 'New research in tidal current energy'.

### Subject Areas:

ocean engineering

### Keywords:

renewable energy, tidal energy, barrages or lagoons, whole system modelling, tidal stream, far-field effects

### Author for correspondence:

Nick Yates

e-mail: [nyatesuk@yahoo.co.uk](mailto:nyatesuk@yahoo.co.uk)

# Appraising the extractable tidal energy resource of the UK's western coastal waters

Nick Yates<sup>1</sup>, Ian Walkington<sup>1</sup>, Richard Burrows<sup>1</sup>  
and Judith Wolf<sup>2</sup>

<sup>1</sup>Centre for Engineering Sustainability, School of Engineering, University of Liverpool, Brownlow Hill, Liverpool L69 3GH, UK

<sup>2</sup>National Oceanography Centre, Joseph Proudman Building, Brownlow Street, Liverpool L3 5DA, UK

A two-dimensional west coast tidal model, built on the ADCIRC platform (an unstructured grid two-dimensional depth-integrated shallow water model), has been developed to examine the scope for reliable and fully predictable electricity generation from UK coastal waters using an ambitious combination of estuary barrages, tidal lagoons and tidal stream generator arrays. The main emphasis has been towards conjunctive operation of major estuary barrages, initially including the presence of pilot-scale tidal stream developments, though ambitious exploitation of extensive tidal streams has also been explored.

## 1. Introduction

With concerns mounting over the UK's energy future, as a result of finite and depleting global fossil fuel resources and the effects of climate change, it will soon become paramount that all viable sources of renewable energy are fully exploited. Towards this goal, researchers from the School of Engineering at the University of Liverpool, UK, working with colleagues at the National Oceanography Centre, Liverpool, UK, have developed a west coast tidal model to examine the scope for renewable electricity generation [1].

The geographical location of the UK and the seas that surround it provide internationally enviable renewable resources [2], especially for viable tidal energy extraction [3]. The most attractive locations for harnessing tidal power are estuaries with a high tidal range for barrages (figure 1) and other areas with large tidal currents (e.g. straits and headlands) for free-standing tidal stream turbines [2].

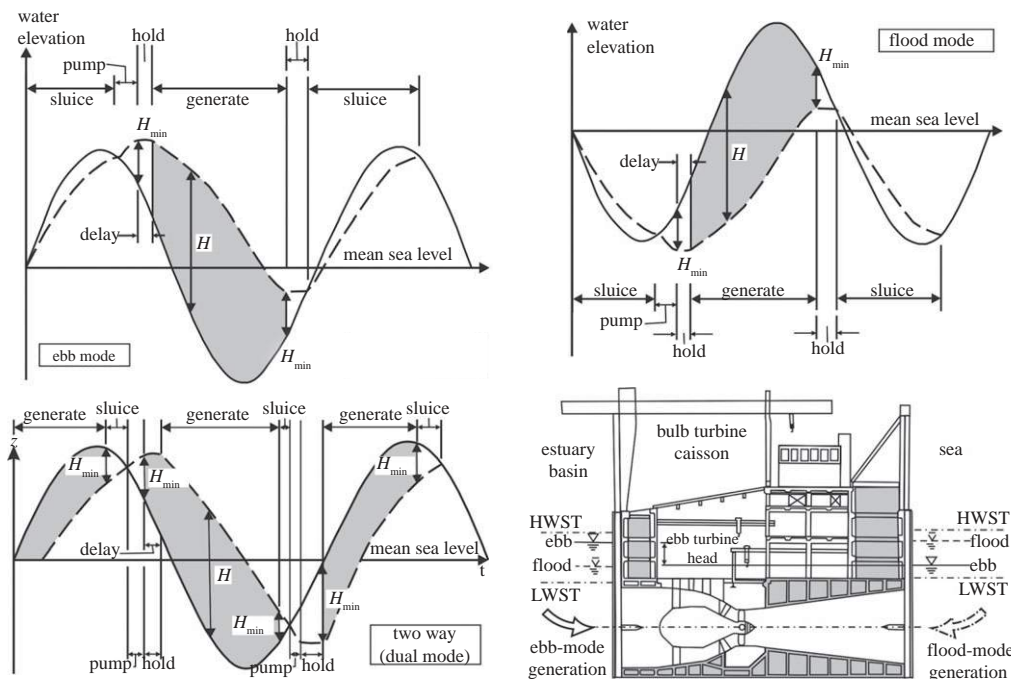

**Figure 1.** Possible modes of operation of a tidal barrage or lagoon together with an illustration of a turbine caisson. Dashed line denotes sea level and solid line denotes basin level. HWST, high water, spring tide; LWST, low water, spring tide.

Crucial here is the fact that tidal barrage solutions, drawing on established low-head hydropower technology, are fully proved, the La Rance scheme in France having passed its 40th year of operation. Suitable sites are relatively few globally. Of about 500–1000 TWh yr<sup>-1</sup> of energy potentially available worldwide, it was earlier estimated that the UK holds approximately 50 TWh yr<sup>-1</sup>, about half of the European resource, and few sites worldwide are as close to electricity users and the transmission grid as those in the UK, making its connection energy efficient [3–6].

Tidal barrages delay the natural motion of the estuary flows as sea level changes: holding back the release of high tide out of the inner estuary basin, for the so-called ‘ebb-mode’ electricity generation when the water level difference across the barrage is sufficient for turbine operation; deferring entry of water into the estuary as tide levels rise (‘flood-mode’ generation); or ‘two-way (dual) mode’, a combination of both (figure 1). Each mode permits generation for typically between 8 and 11 h a day. The barrage inevitably restricts the tidal flows, so reducing the range of tidal levels within the basin, with ebb generation uplifting mean water levels, flood generation reducing mean levels and dual mode resulting in little change in mean water levels, but some reduction in intertidal area. A degree of environmental modification is, therefore, inevitable, and some aspects of this have been discussed by Wolf *et al.* [7].

The northwest of England is well provided for: it has the estuaries of the Dee, Mersey, Morecambe Bay and Solway Firth (figure 2) with a macro-tidal range. Of all potential UK sites, the Mersey, with a very narrow mouth and, therefore, needing a relatively short barrage length, might offer power production at the lowest unit cost of all UK sites, whereas the Severn estuary in the southwest of the UK (figure 2) possesses the second highest tides in the world.

The tidal energy potential of the northwest of England was explored by the authors as part of the Northwest Regional Development Agency-funded 2006–8 Joule study, and some of the results of this study were presented by Burrows and colleagues [8,9] and Wolf *et al.* [7]. Section 2 presents the methodology used to model tidal energy extraction together with a summary of the Joule study results, and §3 presents new model results exploring conjunctive barrage operation and implementation of large-scale tidal stream arrays.

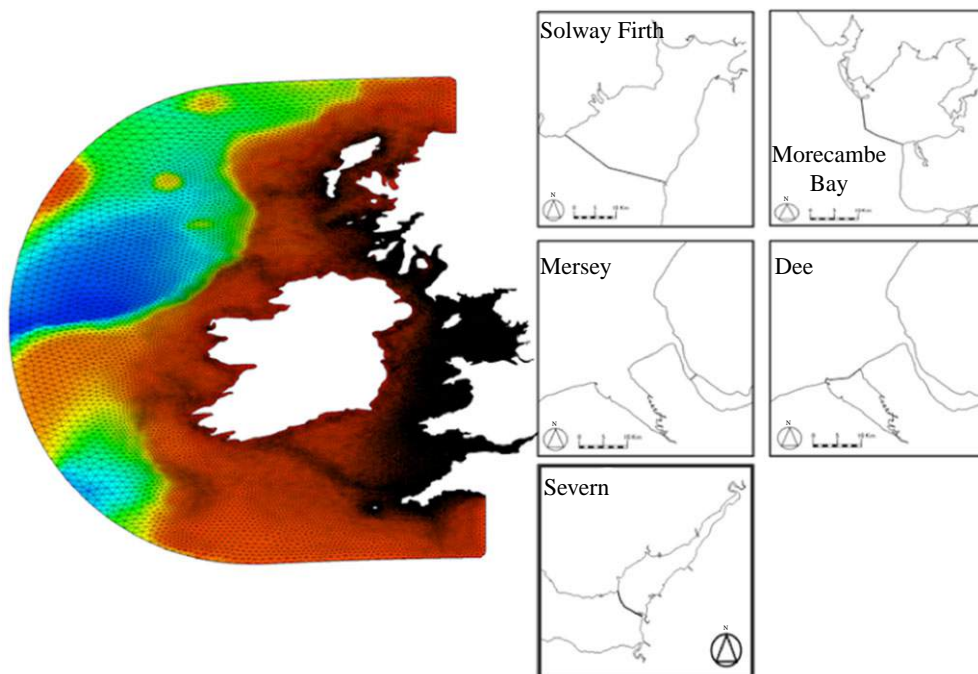

**Figure 2.** Potential tidal barrages considered in the Joule project and the west coast two-dimensional model's computational grid overlaid upon colour-coded bathymetry (water depths). (Online version in colour.)

## 2. Tidal energy modelling

A suite of computational tools was developed as part of the Joule study, for both zero-dimensional modelling (i.e. a 'flat estuary/basin' approach to barrage function) and two-dimensional modelling, capable of treating in detail the hydrodynamics external to the barrage structures or tidal stream devices. These are outlined briefly below.

### (a) Zero-dimensional modelling

Zero-dimensional models are used to represent a lagoon or barrage. Following the approach outlined by Baker [3] and drawing from the theoretical approach of Prandle [10], the underlying equation is

$$S(z) \frac{dz}{dt} = Q(H), \quad (2.1)$$

where  $z$  is the water level in the basin,  $t$  is time,  $S(z)$  is the surface area of the enclosed basin,  $H$  is the difference in water levels across the barrage and  $Q$  is the flux through the barrage. For turbine operation, the flux values are obtained from the turbine operating path, with linear interpolation used to determine exact values.

When sluices are used or the turbines are operating in orifice mode the flux is given by the sluice equation,

$$Q = C_d A \sqrt{2gH}, \quad (2.2)$$

where  $C_d$  is the sluice coefficient and  $A$  is the sluice area (so  $C_d \times A$  is the effective sluice area).

These equations were coded into bespoke Matlab routines, with built-in numerical ordinary differential equation solvers used to provide the solution. A graphical user interface (GUI) front end was also developed (figure 3) to allow parameterization of model runs and, hence, a rapid exploration of barrage configuration parameter space.

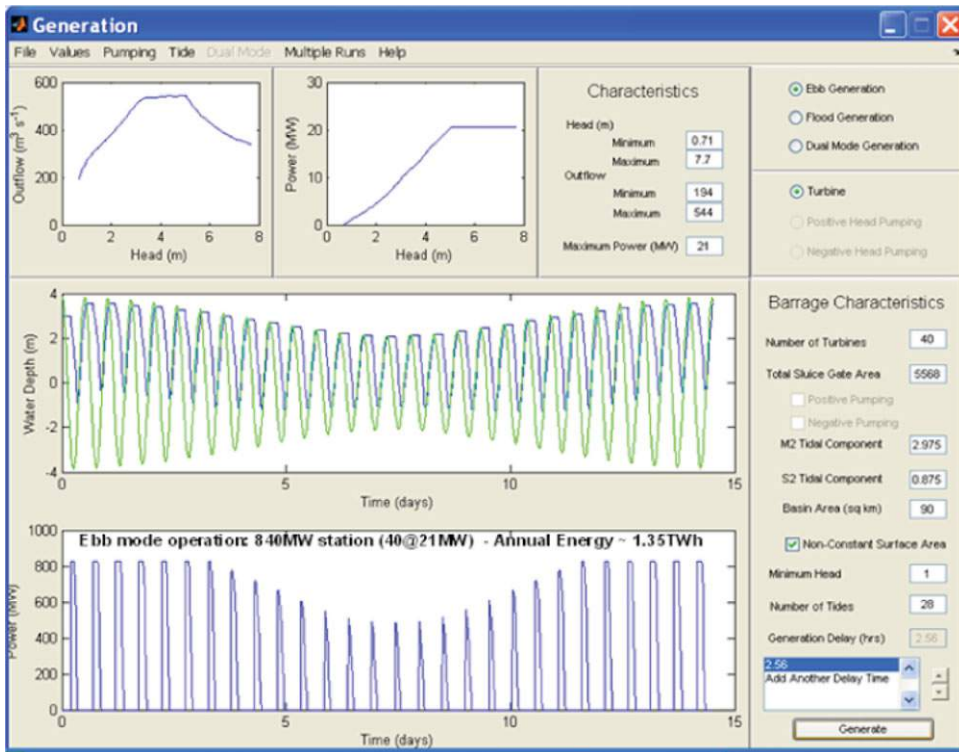

**Figure 3.** Zero-dimensional modelling of energy generation, showing the Matlab GUI developed as part of the Joule study. (Online version in colour.)

## (b) Two-dimensional modelling

Two-dimensional models allow for variation in water level and velocity in both horizontal directions, these being taken to be the depth-averaged values, as there is no velocity resolution through the vertical water column.

The two-dimensional model used for the Joule study was ADCIRC, which is an unstructured grid two-dimensional depth-integrated shallow water model. Formulated in the generalized wave continuity form, it is solved using an unstructured grid approach for the discretization of the mass equation and the momentum equation. Use of an unstructured grid allows a large variation in the scale of regions of interest, which in the Joule study varied from 50 m resolution in estuaries to 10 km at the ocean boundary. ADCIRC is widely used, especially in the USA for tide and surge modelling, and is in constant development, with work ongoing in the areas of adaptive grids, three-dimensional modelling, sediment transport and biological processes.

## (c) Joule study tidal range results

Zero-dimensional modelling was initially used to investigate the different possible operating modes for tidal barrages and lagoons, exploring turbine performance at different barrage sites independently [1,8,9].

Next, fully integrated (two-dimensional) computational modelling was used to investigate estuary barrages (figure 4), operating conjunctively within the tidal marine water domain stretching from the western coastline of the UK out beyond the continental shelf (figure 2). The latter exercise has included the four major northwest estuary barrages plus the (Cardiff–Weston) alignment on the Severn Estuary [1,9].



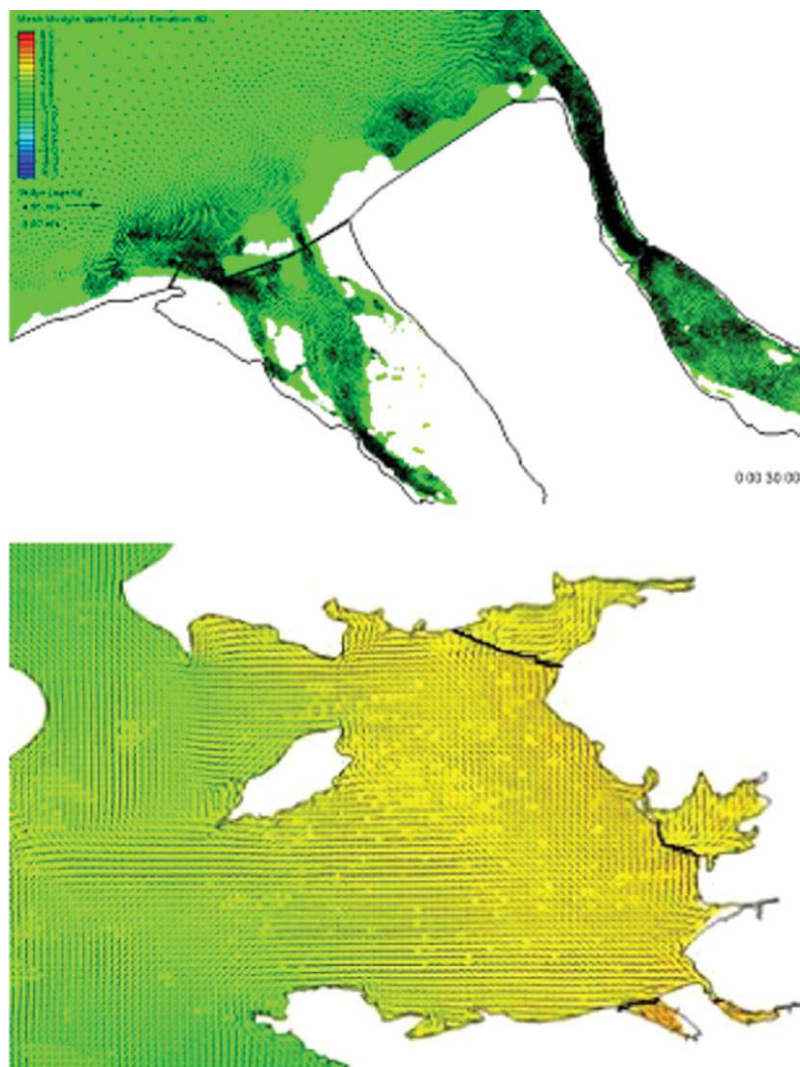

**Figure 4.** Two-dimensional modelling: snapshots of tidal motions with northwest barrages operating, showing tidal direction and wetting and drying. (Online version in colour.)

In the following discussion, a ‘DoEn’ (or  $1 \times \text{DoEn}$ ) barrage installation is taken as one with installed turbine capacity (and complementary sluicing) consistent with the outcomes of the UK Department of Energy’s 1980s studies [2,4–6], with the characteristics of extracting about half of the available energy during ebb generation. This arrangement was found in these early studies to yield electricity at minimum cost. Here, it is adopted as a baseline, because schemes of multiples of this turbine capacity (i.e.  $2 \times \text{DoEn}$ ,  $3 \times \text{DoEn}$ , etc.) were considered as alternatives, operating either in ebb mode or for dual generation.

The zero-dimensional modelling routines consistently under-predicted the DoEn energy generation figures [5,6] by approximately 15 per cent, this being attributable to different assumptions in the treatment of sluicing characteristics, unquantifiable departures in turbine performance characteristics, and the different levels of tide-to-tide control on the selected optimal generation window. Nevertheless, the work confirmed the scale of resource predicted by the DoEn in the 1980s for ebb-only power generation. These  $1 \times \text{DoEn}$  arrangements were also confirmed as generally leading to the lowest cost of energy produced [1,9].

**Table 1.** Zero-dimensional outputs from the Joule study with two-dimensional updates following later reconciliation (see S3a).

barrages	zero-dimensional model	two-dimensional model
$1 \times$ DoEn ebb-mode energy (TWh yr <sup>-1</sup> )		
Solway Firth (7.2 GW)	8.44	8.82
Morecambe Bay (4 GW)	5.83	5.37
Mersey (648 MW)	1.07	0.82
Dee (1050 MW)	1.35	0.83
Severn (8.64 GW)		13.07
$1 \times$ DoEn dual-mode energy (TWh yr <sup>-1</sup> )		
Solway Firth	7.78	6.31
Morecambe Bay	5.75	3.54
Mersey	0.98	0.73
Dee	1.30	0.74
Severn		12.24

In the zero-dimensional studies, different turbine sizes, generator ratings and sluice capacities were investigated, and the 'best' options are shown in table 1.

While these figures are considered to be reasonable estimates of potential energy returns, further turbine conditioning (choice of diameter, generator rating and rated head, etc.) and increased sluice capacity might be expected to further enhance energy capture. Pumping-enhanced operation was shown to increase energy capture further, though only by approximately 10 per cent, somewhat less than might be envisaged [11], partially because of the low pumping efficiencies achievable. At the same time, the detailed hydraulic design of turbine ducts and sluice passageways might give rise to minor (entry/exit) head losses, so reducing the turbine driving head and hence the energy production. As a result of these contrasting factors, there was considered an uncertainty range in the region of  $\pm 10\%$  in the figures produced.

The two-dimensional modelling results presented in table 1 incorporate the negative feedback on tidal motions that the structures create (see tables 2 and 3 for the individual impacts of barrages), though this is partially offset by the simulations including the five major tidal constituents (M2, S2, O1, K1 and N2), whereas zero-dimensional modelling employed only the M2 and S2, lunar and solar semi-diurnal, components. Over and beyond this, the two-dimensional modelling accounts for the hydrodynamics required to drive the flows in and out of the estuary impoundments, and for their conveyance through the waters external to the barrage structures. Comparison against the zero-dimensional outcomes is further disadvantaged, because an equivalent level of operational optimization was not applied in setting up the two-dimensional model (common 'start' conditions being applied to each scheme) [1].

The results achieved showed that turbine installations operating in the most cost-effective (ebb) mode, and subject to the above-mentioned negative feedbacks in tidal hydrodynamics, could produce up to 10 per cent of the UK's present electricity need with a good balance in inputs between the schemes in the highly synchronized northwest estuaries and the Severn scheme (figure 5).

Zero-dimensional modelling shows that large installations ( $3 \times$  DoEn) in dual mode potentially offer a considerable increase in energy extraction. The Joule project produced annual energy figures of 17.84 TWh for the Solway Firth, 11.45 TWh for Morecambe Bay, 2.21 TWh for the Dee and 1.72 TWh for the Mersey to compare against the  $1 \times$  DoEn figures in table 1. Accounting for the external hydrodynamic constraints, as incorporated into the two-dimensional modelling, shows a reduction from the zero-dimensional figures, partially arising from the greater effects of bed friction under the higher flows.

**Table 2.** Changes in mean tidal amplitude from the presence of all five tidal barrages operating conjunctively in ebb ( $1 \times \text{DoEn}$ ) mode.

barrages	M2 component (m)	
	amplitude	difference
Solway Firth	2.50	−0.14
Morecambe Bay	2.84	−0.15
Mersey	2.82	−0.36
Dee	2.32	−0.56
Severn	3.10	−0.80

**Table 3.** Changes in mean tidal amplitude from the presence of each tidal barrage operating individually in ebb ( $1 \times \text{DoEn}$ ) mode.

barrages	M2 component (m)	
	amplitude	difference
Solway Firth	2.50	−0.14
Morecambe Bay	2.84	−0.15
Mersey	2.74	−0.44
Dee	2.20	−0.68
Severn	3.19	−0.71

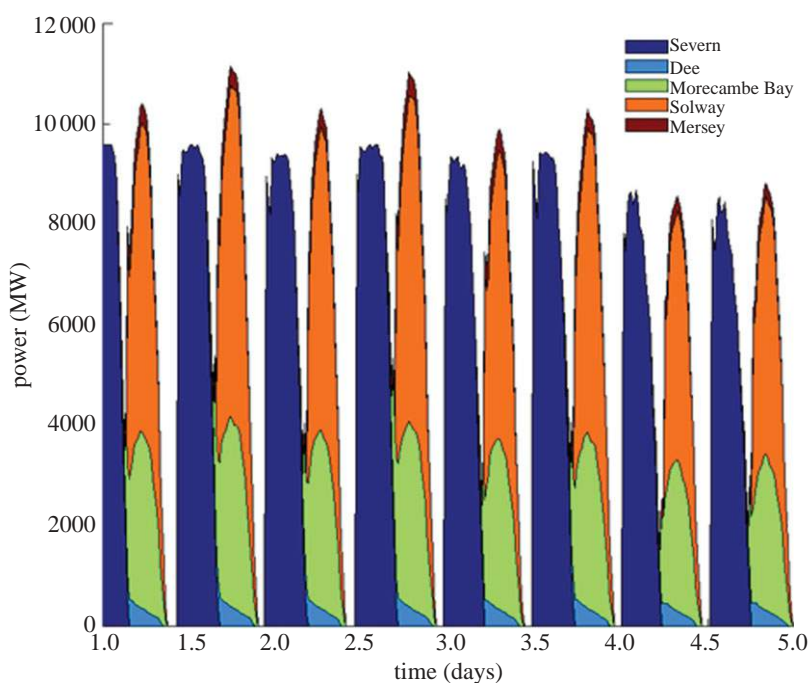
**Figure 5.** Spring tide power pulses from conjunctive operation of the five barrages in ebb ( $1 \times \text{DoEn}$ ) mode. (Online version in colour.)



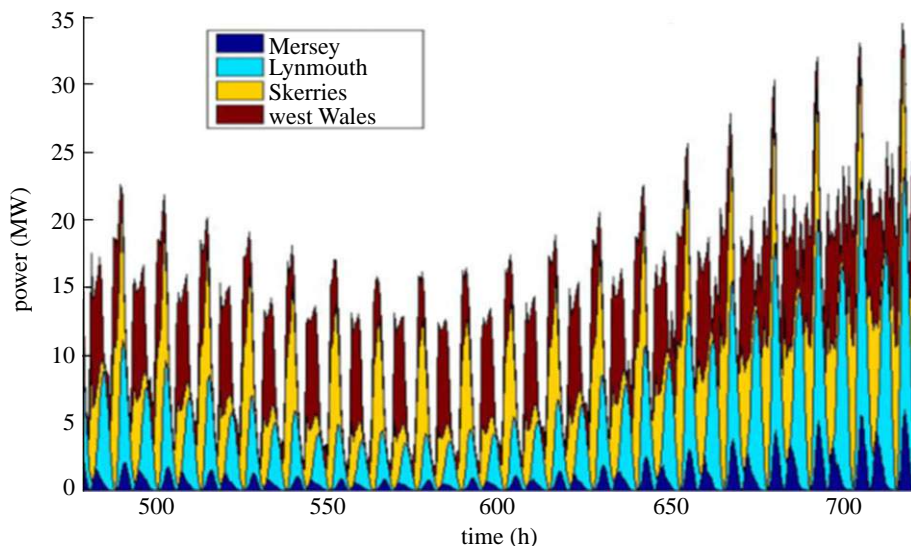

**Figure 6.** Power pulses from the conjunctive operation of the pilot farms (Mersey 20 MW; Lynmouth 30 MW; Skerries 10.5 MW; west Wales 8 MW). Total annual energy output  $112 \text{ GWh yr}^{-1}$ . (Online version in colour.)

It was concluded that the schemes on the Solway Firth, Morecambe Bay, Mersey and the Dee (with an integrated Wirral lagoon) could provide more than 5 per cent of the northwest region's need. Furthermore, the pulses in electrical output from the northwest and the Severn in ebb mode are out of phase so that they operate in complementary fashion and extend the daily generation window to nearly 20 h (figure 5).

A preliminary (zero-dimensional) appraisal of an offshore lagoon installation was also found to be economically uncompetitive in comparison with the estuary barrages [1].

#### (d) Joule study tidal stream results

Pilot-scale and estuary-located free-stream tidal turbines in array or fence configurations were also investigated in the two-dimensional ADCIRC model, modelled as enhanced quadratic bed stress following the approach employed in Sutherland *et al.* [12]. These small-scale tidal stream studies included operation in conjunction with the barrage schemes [1,13], but were shown to offer only a modest energy capture potential compared with the tidal range (barrage) solutions within the Irish Sea, as shown in figure 6. More detail on the small-scale array modelling is presented in Walkington & Burrows [13].

### 3. New model results

#### (a) Investigating the complexity of tidal motions

Since completion of the Joule study, further investigation of the sensitivity of the two-dimensional ADCIRC numerical model to issues such as grid resolution and time-stepping, as well of barrage operation issues such as rates of 'ramping' on turbine and sluice flows, has been undertaken. Exploration of some of the issues so detected, in particular the generation of 'seiche' within the basin arising from abrupt status changes, together with the removal (synthesizing dredging) of significant channel constrictions on flow, has led to the revision of the original energy predictions to those given in table 1. In particular, these sensitivity studies have demonstrated the development of lateral hydraulic gradients across the width of sluice blocks during operation, where these are placed in constrained environments such as the Dee and Mersey without widening of the flow channels to account for likely self-scour.

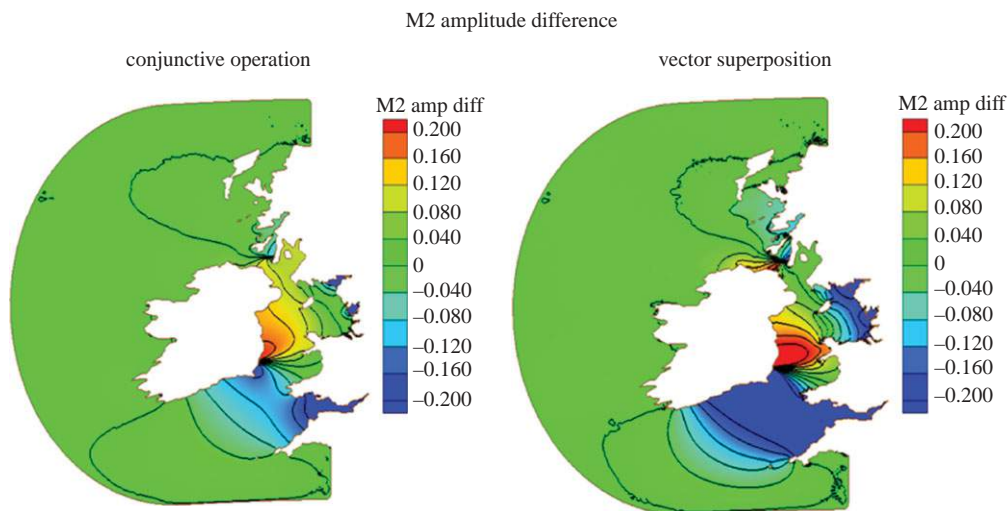

**Figure 7.** Demonstrating the need for simulations of multiple schemes operating in conjunction. (Online version in colour.)

It has also been possible to demonstrate the nonlinearity of the impacts of the energy extraction upon tidal dynamics, hence the need for simulation of conjunctive operation of multiple major tidal energy systems. Figure 7 demonstrates the differences in mean tidal amplitude arising from the proper treatment, simulating the five barrages operating conjunctively, against the incorrect assumption that incremental changes arising from individual scheme developments can be summed linearly. While these results are qualitatively correct, caution needs to be exercised in their interpretation, as the (non-radiative) southern model boundary is at an insufficient distance from the Severn, potentially causing some distortion of model results via wave reflection at that boundary.

## (b) Speculative investigation of 'full' exploitation of tidal streams

As a preliminary to an investigation of the full complement of potential tidal stream developments in conjunction with the five tidal barrage schemes of the Joule study, an ambitious hypothetical development has been considered between the Isle of Man (IoM) and the coast of Scotland, as shown in figures 8 and 9 to represent an 'ultimate' exploitation of the resource.

Assuming installation of approximately 1 MW devices at about  $18 \text{ km}^{-2}$  (based on diameter and wind turbine packing densities), a total of 6 GW of turbines has been assumed in a total (triangular) area of  $350 \text{ km}^2$ . Figure 10 shows the changes in peak tidal current arising from the impedance created, and simulated by enhanced bed-friction within the model. It is clear that a reduction of flux occurs through the simulated farm, and some diversion is seen around the extremity, as might be expected, but no significant flow enhancement to the south of the island is apparent.

Unlike one-dimensional models such as that described by Garret & Cummins [14], this 'full' exploitation has not sought to limit tidal changes. In addition, the model has calculated the resulting hydrodynamic changes and flux reorganization, and so there is no need to apply a significant impact factor to the unmodified kinetic energy flows. As a sanity check of this installed capacity, the maximum unmodified kinetic energy flux was calculated for the transect shown in figure 9, and found to be 4 GW.

Total annual energy output simulated, at 14.5 TWh, is highly encouraging though this remains provisional, pending further validation testing. It also takes no account of practical considerations and constraints. Nevertheless, the scale of the extraction exceeds that achieved by the adjacent major Solway Firth barrage scheme, with its outputs presented earlier in table 1. Figures 11

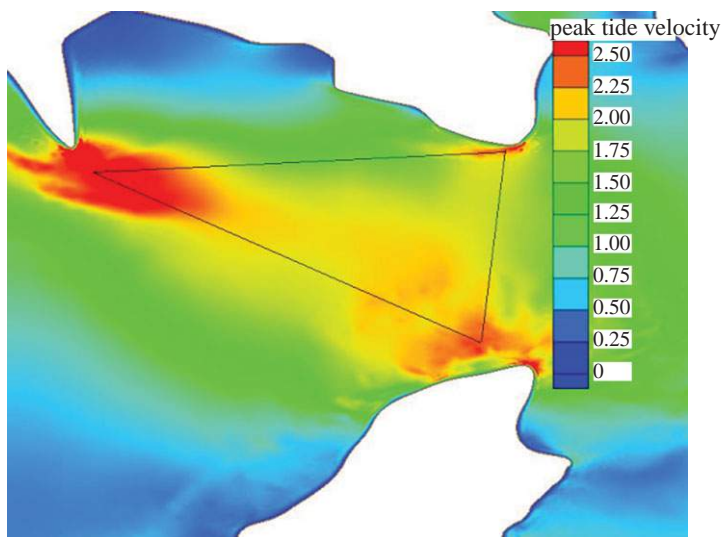

**Figure 8.** Triangular area within which the 6 GW tidal stream farm is located (maximum tidal velocities shown are for the unmodified tides). (Online version in colour.)

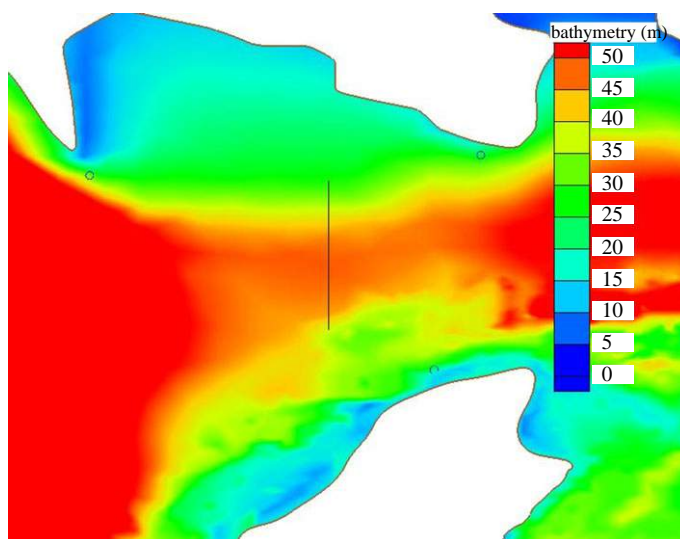

**Figure 9.** Bathymetry for the area within which the tidal stream farm is located; the black vertical line shows the transect used to estimate kinetic energy flux through the region. (Online version in colour.)

and 12 serve to demonstrate that both of these schemes, at capacity ratings of 6 and 7.2 GW, respectively, have a qualitatively similar impact on the tidal dynamics in this region of complex tidal motions.

A full simulation of the conjunctive operation of the five barrages considered herein with major tidal stream developments has been made subsequent to this paper (see Yates [15]). Results from the superposition of individual (non-conjunctive) model runs for the ambitious IoM tidal stream farm, and the conjunctive five barrages in  $1 \times$  DoEn ebb mode from the Joule study, are shown in figures 13 and 14 for neap and spring tides. These indicate that the combination of tidal stream farms and tidal barrages has the potential to provide continuous base load electricity generation.

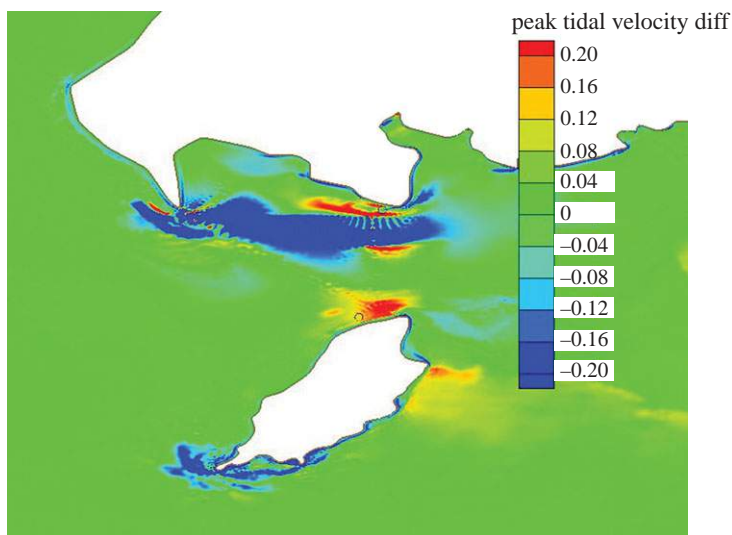

**Figure 10.** Peak tidal velocity difference (modified less unmodified). (Online version in colour.)

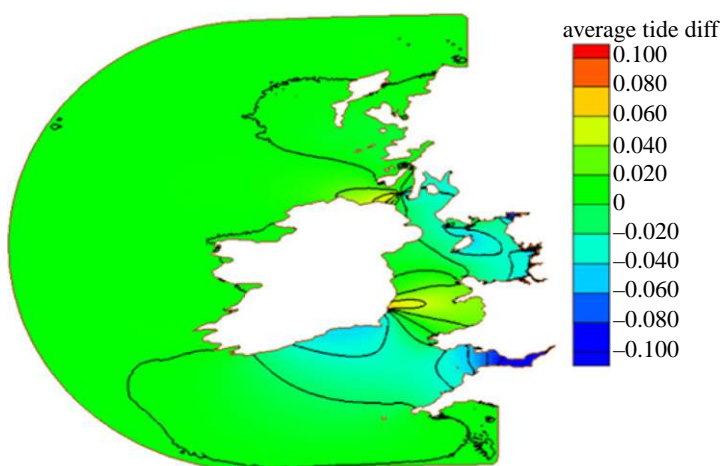
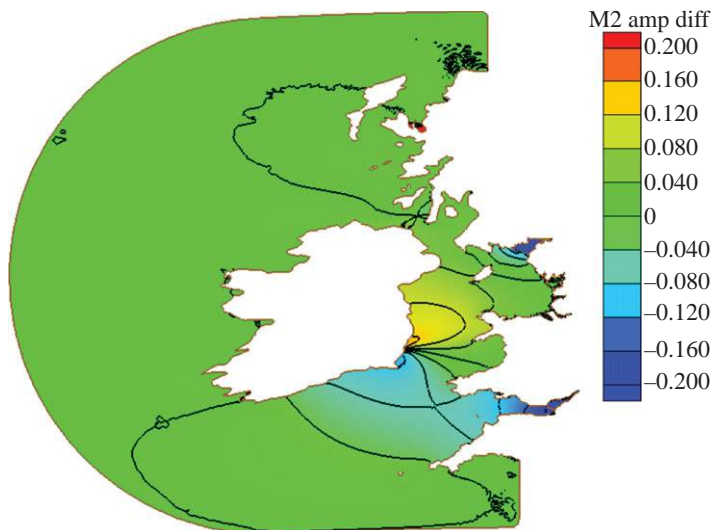

**Figure 11.** Impacts of large-scale tidal stream extraction: 6 GW off the loM—effect on mean tidal amplitudes. (Online version in colour.)

To leading order, each barrage may be optimized individually, though, as seen in table 3, the Severn barrage appears to be influencing the results obtained for the Mersey and the Dee. Tidal stream farms have yet to be optimized.

## 4. Discussion and conclusions

Over and beyond those schemes considered herein, barrage schemes on the east coast of the UK, including the Wash, Humber, Thames, and potentially the Forth and Tay, partially by reason of their tidal phase lags, may be expected to enable further extension of the daily tidal energy generation ‘window’ (depicted in figure 5) and would increase energy capture. By adding ‘pumped storage’ operation and considering a large number of smaller schemes [4], it should ultimately enable a 15 per cent contribution to electricity demand to be made from tidal range



**Figure 12.** Effect of the 7.2 GW Solway Firth barrage on mean tidal amplitudes. (Online version in colour.)

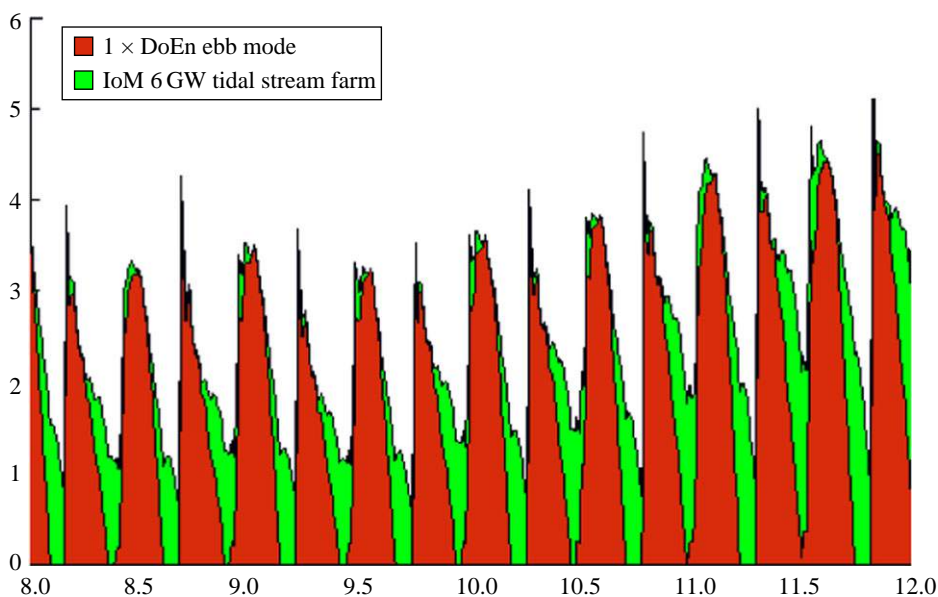
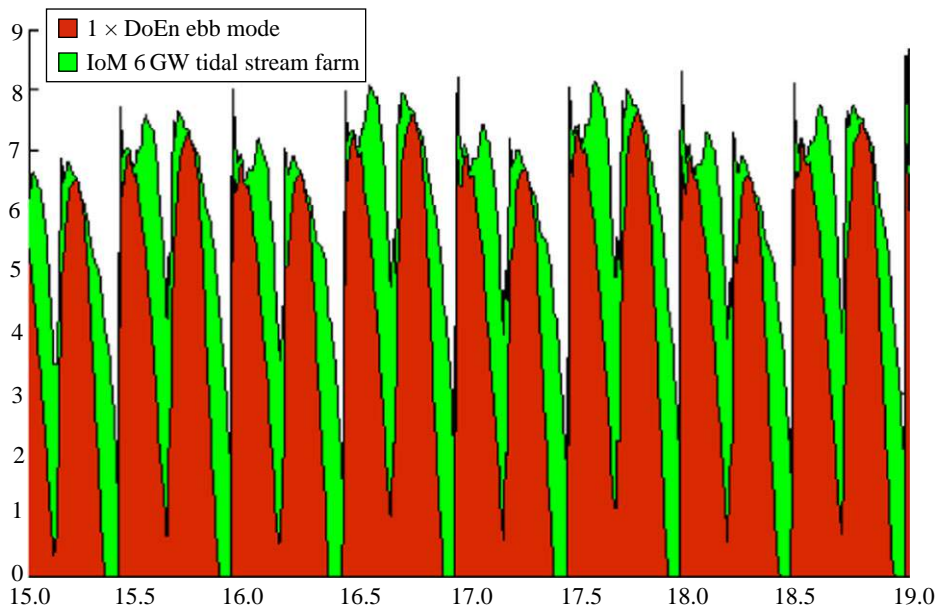

**Figure 13.** Energy pulses from five west coast barrages ( $1 \times$  DoEn ebb mode) and the IoM 6 GW tidal stream farm: neap tides. (Online version in colour.)

energy, at present rates of consumption. Further research is required to fully explore the manner by which the incorporation of pump-assisted filling and emptying can be employed to both increase energy capture [11] and enable a degree of power balancing (pumped storage) across multi-scheme systems. These might include the set of fully exploited tidal stream resources, and some initial modelling work has been done by Yates [15].

Arising from the Joule study, a potential future contribution amounting to 20 per cent of the UK's present electricity demand from tidal energy was envisaged (with a combination of barrages/lagoons (approx. 15%) and present estimates for tidal stream devices (approx. 5%)).





**Figure 14.** Energy pulses from five west coast barrages ( $1 \times$  DoEn ebb mode) and the IoM 6 GW tidal stream farm: spring tides. (Online version in colour.)

The findings from the ‘full’ exploitation of the IoM’s resources shown here is indicative that the tidal stream energy extraction potential of UK waters may be somewhat larger than presently envisaged, with the further advantage that this energy could also close the generation gap from west coast barrages, allowing tidal energy to deliver base load power.

In closure, it is difficult to foresee achievement of the European Union-mandated target for the UK of 15 per cent renewable energies (heating/cooling, transport and electricity), and implying 35–44% of electricity to be sourced from renewables by 2020, nor the UK government’s ambitious 80 per cent CO<sub>2</sub> reduction by 2050, without increasing exploitation of the tidal resource.

The original study was undertaken as part of project JIRP 106/03, which was financially supported over the period 2006–8 by the Northwest Regional Development Agency through the Joule Centre. Subsequent ongoing developments are being funded by an EPSRC Doctoral Training Award to N.Y.

## References

1. Burrows R *et al.* 2009. Tapping the tidal potential of the eastern Irish Sea, final report. Joule Project JIRP106/03. University of Liverpool and Proudman Oceanographic Laboratory, Liverpool, UK. See [www.liv.ac.uk/engineering/tidalpower](http://www.liv.ac.uk/engineering/tidalpower).
2. Department of Trade and Industry. 2004 Atlas of marine renewable energy resources: technical report. Report no. R1106. ABP Marine Environmental Research Ltd, Southampton, UK.
3. Baker AC. 1991 *Tidal power*. IEEE energy series 5. London, UK: Peter Peregrinus Ltd.
4. Department of Energy. 1989 The potential for tidal energy from small estuaries. ETSU TID 4048P1. Department of Energy, London, UK.
5. United Kingdom Atomic Energy Authority. 1981 Preliminary survey of tidal energy of UK estuaries, Severn tidal power. Report STP-102. United Kingdom Atomic Energy Authority, Oxford, UK.
6. United Kingdom Atomic Energy Authority. 1984 Preliminary survey of small scale tidal energy, Severn tidal power. Report STP-4035 C. United Kingdom Atomic Energy Authority, Oxford, UK.
7. Wolf J, Walkington IA, Holt J, Burrows R. 2009 Environmental impacts of tidal power schemes. *Proc. ICE Maritime Eng.* **162**, 165–177. (doi:10.1680/maen.2009.162.4.165)

8. Burrows R. 2009 Tidal energy potential in UK waters. *Proc. ICE Maritime Eng.* **162**, 155–164. (doi:10.1680/maen.2009.162.4.155)
9. Burrows R, Walkington IA, Yates NC, Hedges TS, Wolf J, Holt J. 2009 The tidal range energy potential of the west coast of the United Kingdom. *Appl. Ocean Res.* **31**, 229–238. (doi:10.1016/j.apor.2009.10.002)
10. Prandle D. 1984 Simple theory for designing tidal power schemes. *Adv. Water Resour.* **7**, 21–27. (doi:10.1016/0309-1708(84)90026-5)
11. MacKay DJC. 2009 *Sustainable energy: without the hot air*. Cambridge, UK: UIT Ltd.
12. Sutherland G, Foreman M, Garrett C. 2007 Tidal current energy assessment for Johnstone Strait, Vancouver Island. *Proc. Inst. Mech. Eng. A, J. Power Energy* **221**, 147–157. (doi:10.1243/09576509JPE338)
13. Walkington I, Burrows R. 2009 Modelling tidal stream power potential. *Appl. Ocean Res.* **31**, 239–245. (doi:10.1016/j.apor.2009.10.007)
14. Garrett C, Cummins P. 2005 The power potential of tidal currents in channels. *Proc. R. Soc. A* **461**, 2563–2572. (doi:10.1098/rspa.2005.1494)
15. Yates NC. 2012 Tidal energy resources of the UK's estuaries and coastal waters. PhD thesis, University of Liverpool, UK.